

THERMANN™

OWNER'S GUIDE

Thermann Split Heat Pump

**Operating Instructions
Warranty**

Models

Tank Unit: TH160GLG, TH250GLG,
TH315GLG, TH400GLG

Heat Pump Unit: THP45

System Model: THP45x160,
THP45x250, THP45x315,
THP45x400





Thermann Owner's Manual

Thermann Split Heat Pump













CONTENTS

Important Safety Instructions	4-5
Introduction	6
Typical Installation Layout	7
Time and Block Out Setting	8-9
System Maintenance	11
Technical Data - Heat Pump Unit	13
Technical Data - Tank	15
Water Supply Quality	16
Warranty Policy	17











IMPORTANT SAFETY INSTRUCTIONS

 Warning	The column with this classification indicates “the extent of harm that includes the possibility of death or serious injury”.
 Caution	The column with this classification indicates “the extent of harm/ damage that includes the possibility of injury or damage to property.”



Warning

-  Do not open the heat pump unit cover.
-  Do not poke anything into the air inlet or outlet of the heat pump unit
-  Do not touch the tap while hot water is being supplied.
-  Check the water temperature before supplying any hot water or taking a shower.
-  Do not disassemble, repair or alter the product in any way.
-  Do not use any damaged, altered, or bundled power code.
-  Do not touch the PTR valve, drainage pipe, drain outlet or drain elbow when inspecting the PTR valve or while draining hot water.
-  Ensure the product is removed from any gas containers, source of fire and flammable substances.
-  For continued safety of this appliance it must be installed, operated and maintained in accordance with the manufacturer's instructions.
-  System contains refrigerant under very high pressure. The system must be serviced by qualified persons only.
-  This appliance may deliver water at high temperature. Refer to the Plumbing Code of Australia(PCA), local requirements and installation instructions to determine if additional delivery temperature control is required.
-  If the hot water system is not used for two weeks or more a quantity of highly flammable hydrogen gas may accumulate in the water heater. To dissipate this gas safely, it is recommended that a hot tap be turned on for several minutes or until discharge of gas ceases. Use a sink, basin, or bath outlet, but not a dishwasher, clothes washer, or other appliance.
During this procedure, there must be no smoking, open flame, or any electrical appliance operating nearby. If hydrogen is discharged through the tap, it will probably make an unusual sound as with air escaping.

Caution

-  Do not block the air inlet and outlet.
-  Do not climb or put anything on top of the heat pump unit.
-  Do not put anything susceptible to humidity under the heat pump unit.
-  Do not use the heat pump unit if the installation blocks have been damaged.
-  Ensure no animal or plant is placed directly in front of where air is blown from the heat pump unit.
-  In the case of any abnormality turn the earth leakage breaker to “OFF”.
-  Select an installation place with consideration given to neighbours.
-  Remove any snow from the heat pump units after snowfalls.
-  Do not run the hot water directly into sink outlets etc.
-  Do not use the shower or any hot water for at least one minute after recovery from a power cut.
-  Do not install the unit anywhere it will be exposed to seawater.

IMPORTANT SAFETY INSTRUCTIONS (CONT.)

	Indicates content requiring “attention”
	Indicates content that is prohibited.
	Indicates content with “instructions” that need to be fully followed.

WARNING

This appliance is not to be used by persons (including children) with reduced physical, sensory or mental capabilities, or lack of experience and knowledge, unless they have been given supervision or instruction.

Children being supervised are not to play with the appliance.

WARRANTY

Thermann Split Heat Pump hot water units are covered by Reece for any cost of labour and parts in the event of a component failure due to any defects that may arise either from workmanship and/or faulty material. **Product must be installed by a licensed plumber**

The warranty commences on the date of installation :

RESIDENTIAL USE:

HEAT PUMP UNIT

TANK

PARTS & LABOUR



COMMERCIAL USE:

HEAT PUMP UNIT

TANK

PARTS & LABOUR



INTRODUCTION

The Thermann Split Heat Pump is designed to efficiently and effectively heat water in domestic applications. This product is an external CO₂ Heat Pump water heater. These units are designed to be installed outside and as a kit (tank and heat pump unit).

Thermann Split Heat Pump units are manufactured to have a factory output of 65°C as standard. Where connected directly to sanitary fixtures used primarily for the purposes of personal hygiene, it must be fitted with an approved tempering valve into the hot water piping to any bathroom and/or ensuite.

IMPORTANT NOTE: THIS HOT WATER UNIT IS NOT FOR POOL OR SPA HEATING

GENERAL

The Thermann Split Heat Pump must be installed in accordance with the following:

- (1) Plumbing Code of Australia;
- (2) Installed to meet AS/NZS3500.4 National plumbing and drainage (part 4) code hot water supply systems – acceptable solutions.
- (3) Installed to meet HB 263-2004 Heated water systems plumbing industry commission.
- (4) Installed to meet AS/NZS 3000.4 Electrical installations (known as the Australian/ New Zealand wiring rules).
- (5) The unit has been specifically designed for domestic hot water heating and is not suitable for any other purpose. **If installed in a commercial application, then warranties will be reduced to 1 year for both Tank, Heat pump unit and parts and labour.**
- (6) The unit is designed to operate when connected to the town water supply with a maximum operating pressure of **500kPa**. To ensure the mains pressure does not exceed this, a pressure-limiting device that complies with AS1357 must be connected to the town water supply line.
- (7) This system delivers hot water exceeding 50°C. Reference should be made to AS/NZ3500. 4 and/or local regulations relating to the need for temperature tempering devices.
- (8) The unit must be stored and transported in an upright position. Failure to do so may render the unit faulty. Such failure is not covered under any warranty agreements.

INSTALLATION MUST BE CARRIED OUT ONLY BY AN AUTHORISED AND APPROPRIATELY LICENSED PERSON.

TYPICAL INSTALLATION LAYOUT

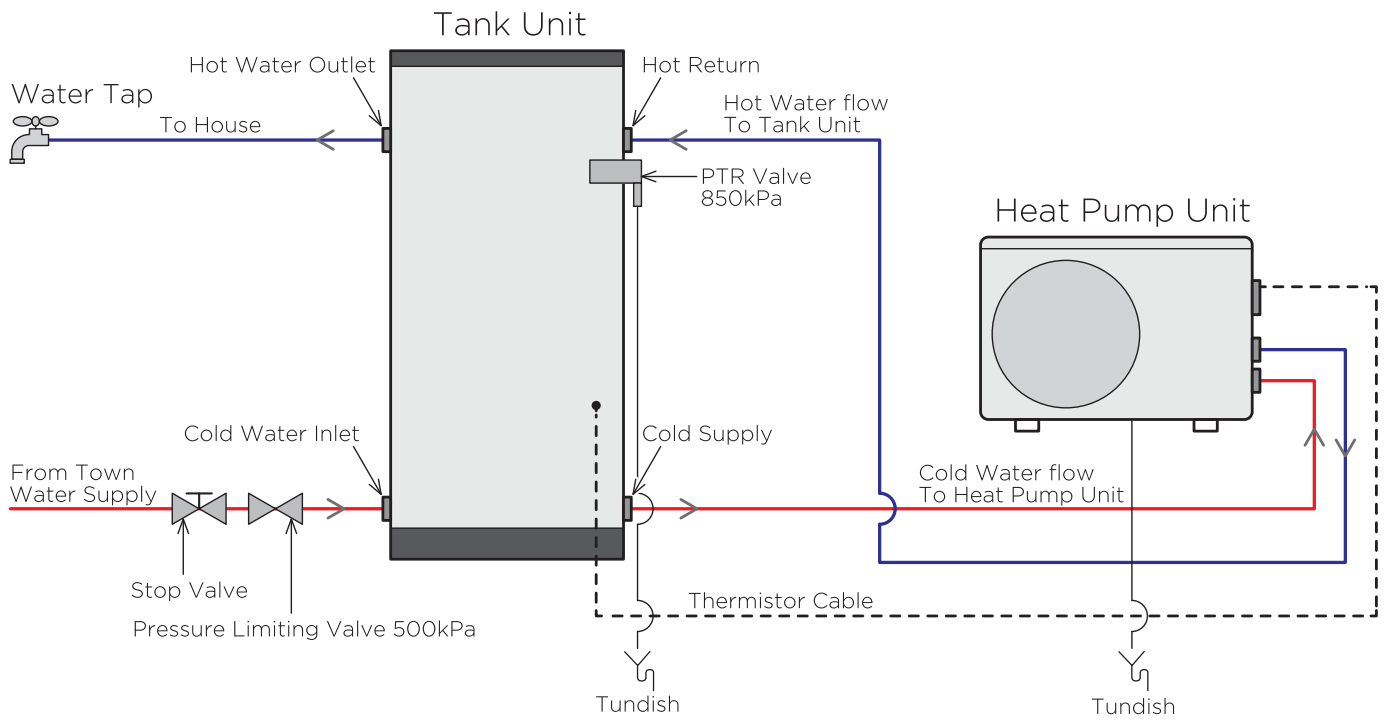

TIME AND BLOCK OUT SETTING

CURRENT TIME SETTING

This product contains a built-in clock as part of the water heating cycle logic and refers to the current time. It is necessary to set the clock before starting to use the product. The current time can be set in the 'Clock Setting Mode' as described below.

Note :

There is no need to adjust the time setting for the daylight saving period. Even if the installation is conducted during the daylight saving period, the clock setting to the ordinary time (not daylight saving time) is preferable.

1. Switching to Clock Setting Mode

Press the "Enter" key in the Clock Display Mode to switch to the Clock Setting Mode. Time Display starts flashing once the mode is switched.

2. Setting the Clock

The time setting can be adjusted by pressing "▲" and "▼" keys. Fast forward and rewind are available by pressing and holding down a key.

3. Confirming Time Setting

After the clock is adjusted to the current time, press the Enter key to confirm the setting. The time display stops flashing and comes on once the setting is finished.

CAUTION :

The setting automatically goes back to the Clock Display Mode when no panel operation is performed for more than 60 seconds in the Clock Setting Mode. If this occurs, changes made will not be reflected to the setting. Depending on the set time, the system will start its heating cycle.

Note :

If no buttons are pressed on the panel for more than 60, the display goes into sleep mode and the Panel is blank except for the operation status light. Sleep Mode is turned off when any button is pressed. ▲, ▼ or Enter key is pressed.

TIME AND BLOCK OUT SETTING (CONT.)

Figure: How to operate the controller

How to use the operate controller
remove the piping cover (1 screw)

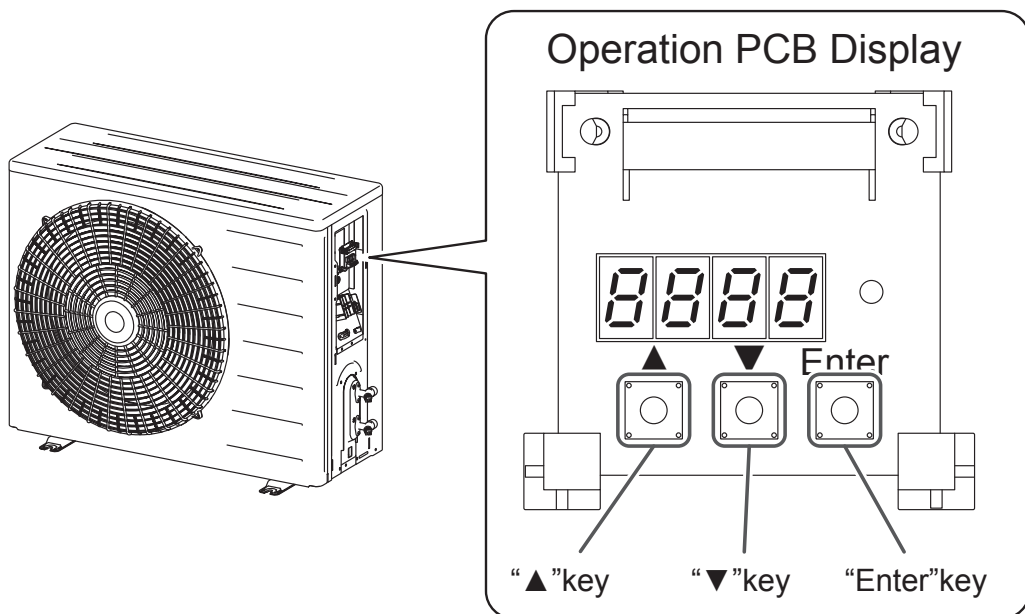
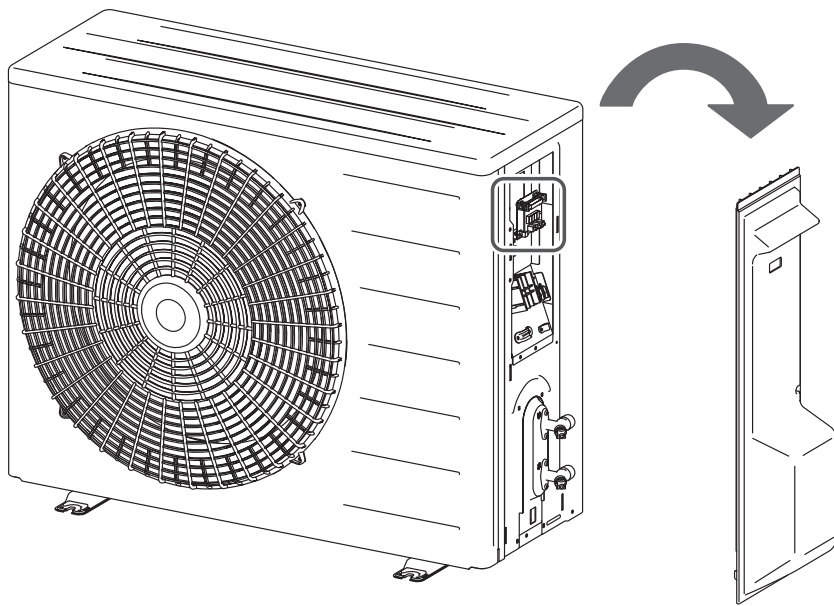

SYSTEM MAINTENANCE

Regular servicing will help to extend the life of the water heater, and keep it operating safely and efficiently. Your water heater warranty is not conditional on completing the regular servicing recommended in this manual.

Six Month Service:

This service may be carried out by the owner.

1. Stand clear of the Pressure & Temperature Relief (PTR) Valve drain pipe outlet.
2. Open the PTR Valve for approximately 10 seconds by lifting the easing lever on the valve. Confirm water discharges to waste through the drain pipe.
3. Lower the easing lever gently and check it closes correctly.

Other than this, personally inspecting or servicing any part of your water heater is not recommended

Five Year Service (All Water Heaters):

This service should only be carried out by a licensed tradesperson. In locations where the water has Total Dissolved Solids (TDS) exceeding 600 mg/L, this service is recommended every 3 years.

The service should include the following:

- Replace the PTR Valve.
- Replace the anode
- Drain and flush the water heater

CONSIDERING A SERVICE CALL?

It is recommended that the following points be reviewed before making a service call:

No Hot Water:

- If you have a heat pump water heater, ensure that the power supply circuit breaker has not “tripped”. If your water heater is on a timed tariff such as off-peak, ensure this is operating correctly.

High Electricity Bills or Insufficient Hot Water:

- Often the hot water usage of showers, washing machines and dishwashers can be under estimated. Review these appliances to determine if your daily usage is greater than the capability of your water heater.
- If necessary check the shower flow rates with a bucket, measuring the amount of water used over that period of time. If it is not possible to adjust water usage patterns, an inexpensive flow control valve can easily be fitted to the shower outlet.
- Do you have the correct size water heater for your requirements? Sizing details are available from your local Reece branch.

- Is there a leaking hot water pipe or dripping hot water tap? A small leak can waste a large quantity of hot water. Replace faulty tap washers and have your plumber rectify any leaking pipe work.
- Is the Pressure & Temperature Relief Valve discharging too much water? See below.

Continuous Trickle of Water from Pressure & Temperature Relief (PTR) Valve:

This is most likely due to a build up of foreign matter. In this case, try gently raising the easing lever on the PTR Valve for a few seconds, then release gently. This may dislodge a small particle of foreign matter and rectify the fault.

Water Discharge from PTR Valve:

It is not unusual for a small quantity of water to discharge during the heating of water in your storage tank. The amount of discharge will depend on hot water usage and size of the storage tank. As a guide, it will discharge about 2% of the volume of the water heated. Continuous leakage of water from the PTR Valve may indicate a problem with the water heater. Turn off or shut down the water heater and contact Customer Service.

TECHNICAL DATA - HEAT PUMP UNIT

Exploded Diagram of Heat Pump Unit

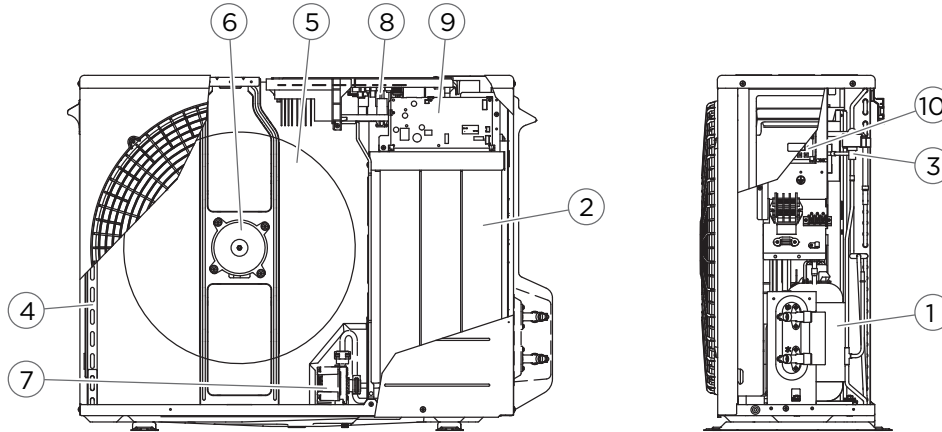

1	COMPRESSOR	6	FAN MOTOR
2	WATER HEAT EXCHANGER	7	CIRCULATION PUMP
3	EXPANSION VALVE	8	MAIN PCB
4	EVAPORATOR	9	CONTROL PCB
5	FAN	10	OPERATION PCB

Heat Pump Dimensions

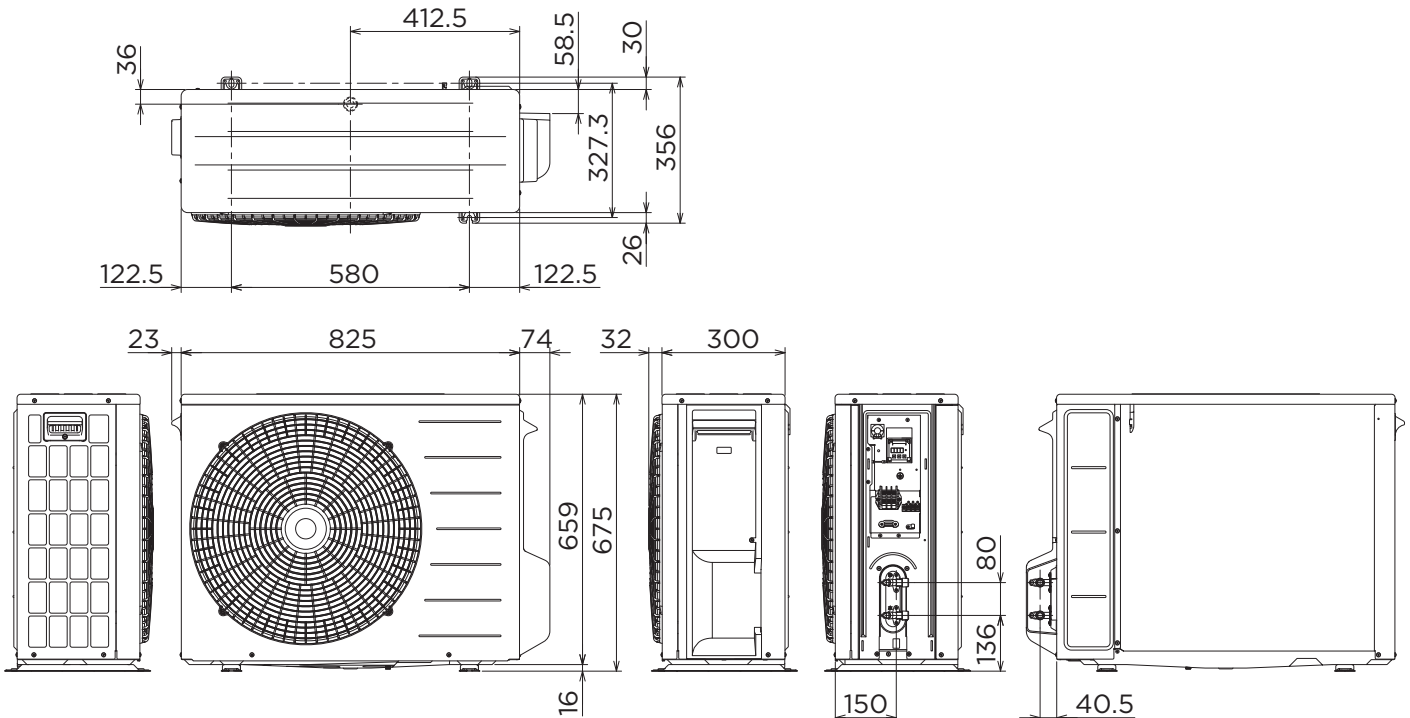

(With the piping cover removed)

Unit : mm

TECHNICAL DATA - HEAT PUMP UNIT (CONT.)

PERFORMANCE DATA

SPECIFICATION	Unit	Data
Power-supply voltage	V	240
Power frequency	Hz	50
Installable outside air temperature	°C	-10 - 43
Product weight	kg	48
Refrigerant type	-	R744 (CO ₂)
Refrigerant weight	g	690
Design pressure (High/Low)	MPa	14/9
Rated capacity	kW	4.5
Max.capacity	kW	6.0
Max.power input	kW	2.5
Max.current	A	11
Setting outlet water	°C	65
Protection rating	-	IPX4
Max.operating water pressure	kPa	850
Noise Level ✖	dB(A)	37
Tank thermistor ON temperature	°C	37
Tank thermistor OFF temperature	°C	57
Installation height difference between the tank and HP	m	Max 5
Piping length between the tank and HP	m	Max 15
Number of bends between the tank and HP	-	Max 6
Allowable water hardness	mg/L	Max 200
Allowable water pH	-	6.5 - 8.0
Circuit breaker size	A	20

✖ Dry bulb 19°C, Wet bulb 15.1°C, Inlet water 15°C, Outlet water 65°C

TECHNICAL DATA - TANK

Tank Specifications

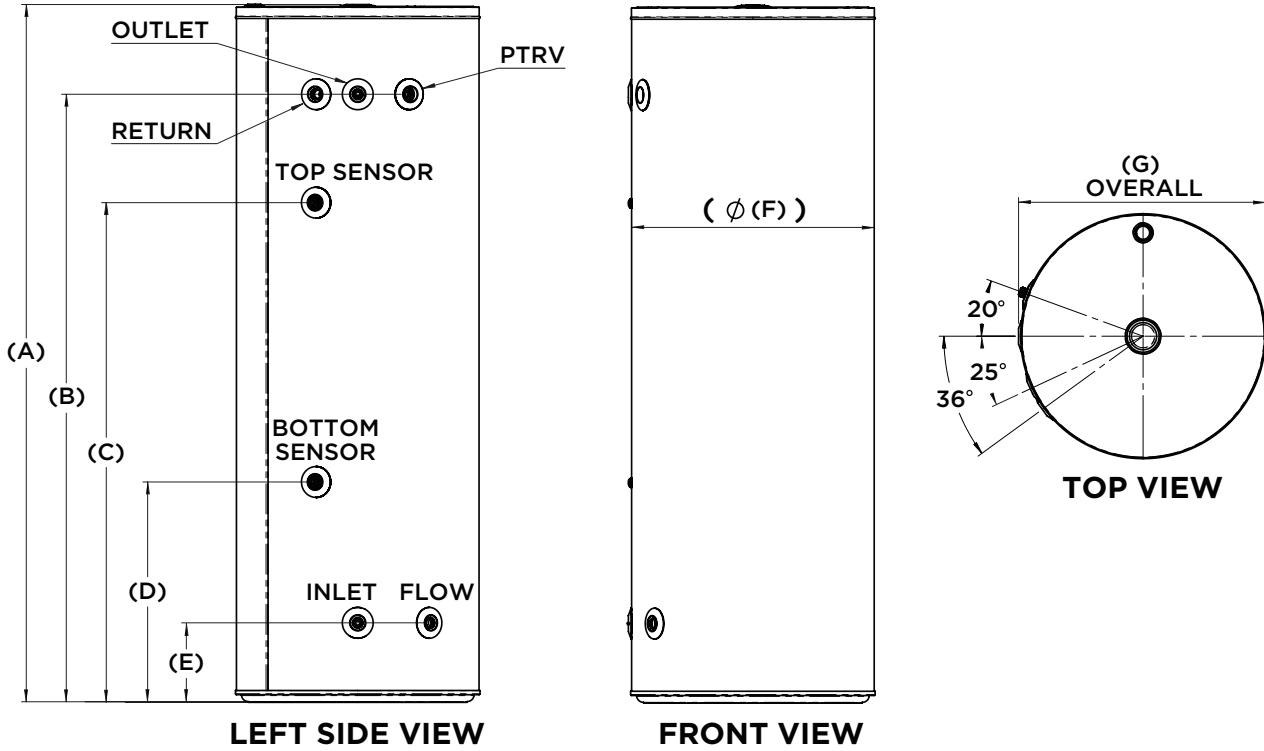

SPECIFICATION				
Model	160L	250L	315L	400L
Total Volume	163L	259L	323L	420L
Tank Unit Weight (Empty)	59kg	71kg	92kg	116kg
PTRV Pressure Pump	850kPa	850kPa	850kPa	850kPa
Sensor Level on Tank	68%	69%	69%	69%
Height (A)	1318mm	1444mm	1762mm	1704mm
Hot Water Outlet (B) PTR Valve (B) Heat Pump Return (B)	1099mm	1217mm	1535mm	1452mm
Top Sensor (C)	936mm	997mm	1263mm	1215mm
Bottom Sensor (D)	439mm	463mm	555mm	561mm
Heat Pump Flow & Cold Inlet (E)	190mm	201mm	201mm	226mm
Cylinder Diameter (F)	528mm	613mm	613mm	701mm
Overall Diameter (G)	540mm	623mm	624mm	712mm

WATER SUPPLY QUALITY

CHLORIDE, WATER HARDNESS AND PH

In high chloride water supply areas, the water can corrode some parts and cause them to fail. Where the chloride level exceeds 200 mg/litre or Water Hardness level exceeds 200 mg/litre, **warranty does not apply** to the heat pump unit and tank unit. pH is a measure of whether the water is alkaline or acidic. In an acidic water supply, the water can corrode some parts and cause them to fail.

No warranty applies to the heat pump unit and tank unit where the pH is less than 6.5 or more than 8. The water supply from a rainwater tank unit in a metropolitan area is likely to be corrosive due to the dissolution of atmospheric contaminants.

Water with a pH less than 6.5 may be treated to raise the pH. It is recommended that an analysis of the water from a rainwater tank be conducted before connecting this type of water supply to the system.

Figure: Water Hardness

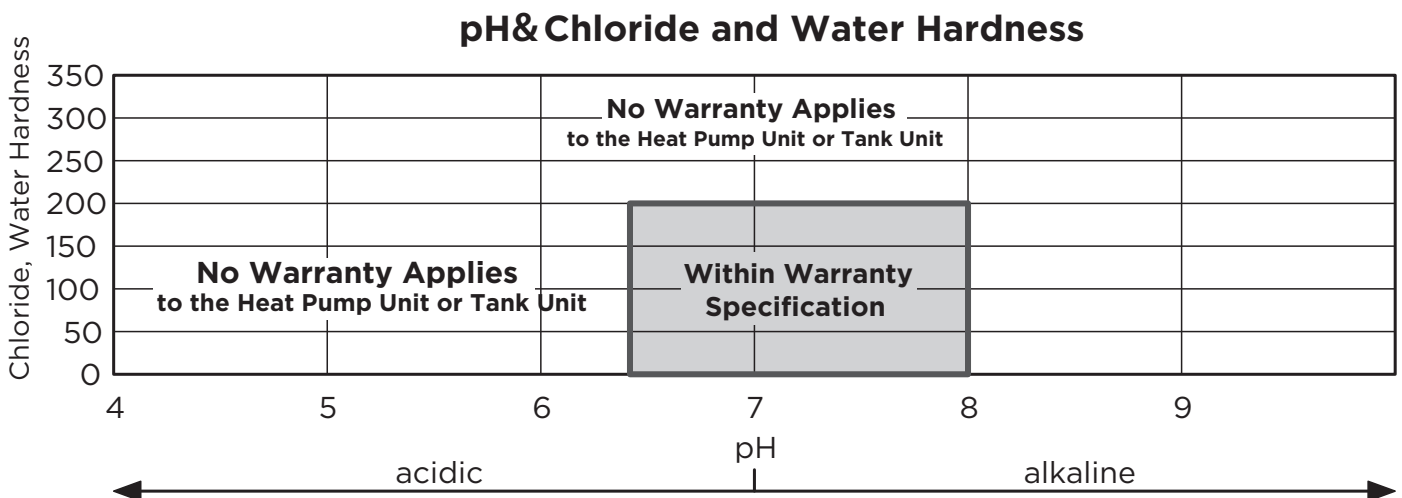

CHANGE OF WATER SUPPLY

Changing, or alternating, from one water supply to another can have a detrimental effect on the operation and/or life expectancy of the water tank unit cylinder, PTR valve, water heating circulation and the water heat exchanger in the system. Where there is a changeover from one water supply to another, for example, a rainwater tank supply, desalinated water supply, public reticulated water supply or water brought in from another supply, then water chemistry information should be sought from the supplier or the water should be tested to ensure it meets the warranty requirements in this installation manual.

WARRANTY POLICY

All Thermann water heaters must be installed in accordance with manufacturer's installation instructions and in accordance with local regulations, building codes and AS/NZS 3000, AS/NZS 3500.4 and AS/NZS 5601.

Where a component may have failed under warranty and is replaced, the component replaced will only be covered by the warranty for the balance of the appliance warranty period.

Water quality must be within limits specified in table below.

pH	6.5 to 8.0
Sodium	Up to 150 mg/litre or ppm
TDS (Total Dissolved Solids)	Up to 600 mg/litre or ppm
Chlorides	Up to 200 mg/litre or ppm
Iron	Up to 1 mg/litre or ppm
Magnesium	Up to 10 mg/litre or ppm
Alkalinity (as CaCO ₃)	Up to 200 mg/litre or ppm
Dissolved (free) CO ₂	Up to 25 mg/litre or ppm
Total Hardness CaCO ₃	Up to 200 mg/litre or ppm

WARRANTY TERMS

Thermann Split Heat Pump hot water systems are covered by Reece for any cost of labour and parts in the event of a component failure due to any defects that may arise either from workmanship and/or faulty material.

The warranty commences on the date of installation:

RESIDENTIAL USE

Heat Pump Unit: 6 years

Tank: 10 years

Parts & Labour: 2 years

COMMERCIAL USE

All components: 1 year

Parts & Labour: 1 year

ADDITIONAL INFORMATION

If your Thermann heat pump was purchased and installed from 1st July 2023 through the SOLAR Victoria - SOLAR HOMES program, your Thermann Heat Pump is warranted for five years on all components.

NEED MORE INFO?

Visit www.thermann.com.au to get the latest product information and explore rest of the Thermann Hot Water range.

